

Signet 2507 Mini Flow Rotor Sensor



Features

- Operating range 400 to 12,000 ml/m (0.1 to 3.2 U.S. gpm)
- Detachable signal connector for easy servicing
- Simple installation with a G 1/4 in. (1/4 in. NPT) threaded connection
- Standard 7.6 m (25 ft) cable
- PVDF construction
- Compact assembly

Description

The Signet 2507 Mini Flow Rotor Sensor contains a free-running rotor that is driven by the fluid flow. Within the given measurement range, the rotational speed of the rotor is proportional to the fluid flow rate.





Magnets built into the rotor trigger an electronic switch in the top of the sensor creating a square-wave output. Both opaque and transparent fluids can be measured with kinematic viscosities between 0.2 to 20.0 centistokes.

Applications

- Fluid Dispensing
- Laboratory and Clinical Wet Benches
- Chemical Dosing
- Batch Processes



System Overview

<p>Panel Mount</p> <p>Signet Flow Instrument (sold separately)</p> <p>5075 8550 5500 8900 5600</p> 	<p>Pipe, Tank, Wall Mount</p> <p>Signet Flow Instrument (sold separately) 8550</p>  <p>Signet Universal Adapter Kit (3-8050) (sold separately)</p> 
<p>Signet 2507 Mini Flow Sensor</p> 	
<p>Signet Pipe Fitting Adapters (two included) Used to convert the sensor's G1/4 in. straight threads into 1/4 in. NPT threads</p> 	

Dimensions

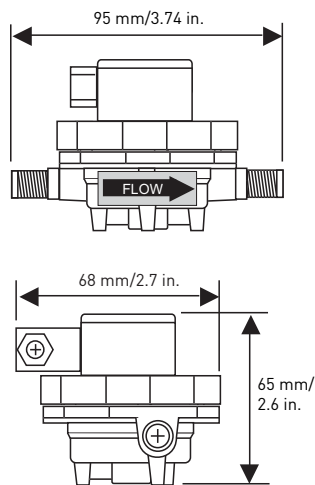

Detachable Signal Connector

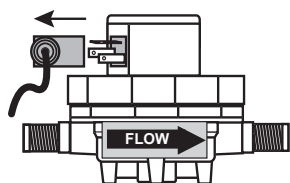

Top View
(cover removed)

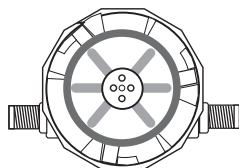

Application Tips

- Use the threaded ports on bottom of sensor to secure the sensor to any flat surface.
- The range of any sensor can be changed by replacing the flow insert.
- Suitable only for clean fluids without particles.

Please refer to **Wiring, Installation, and Accessories** sections for more information.

Specifications

General

Operating Range:

- -2V sensor: 400 to 2800 mL/m (0.105 to 0.740 U.S. gpm)
- -3V sensor: 700 to 4200 mL/m (0.185 to 1.123 U.S. gpm)
- -4V sensor: 1300 to 6000 mL/m (0.343 to 1.585 U.S. gpm)
- -6V sensor: 3200 to 12000 mL/m (0.845 to 3.170 U.S. gpm)

Linearity: ±0.25% of full range

Repeatability: ±0.25% of full range

Viscosity range: 0.2 to 20.0 centistokes

Connections:

- G 1/4 in. ports, 1/4 in. NPT pipe adapters (2 included)

Wetted Materials

- Housing: PVDF
- Flow insert: PTFE
- Quad ring seal: FPM
- Rotor: PVDF
- Pipe thread adapters: PVDF

Electrical

Power:

- 5 to 24 VDC ±10%, regulated, 10 mA max

Output Type:

- Open-collector, sinking, 10 mA max.

Cable Length:

- 7.6 m (25 ft), can be extended up to 300 m (1000 ft)

Cable Type:

- 2-conductor shielded twisted-pair, 22 AWG

Max. Temperature/Pressure Rating

- 5.5 bar @ -18 °C (80 psi @ 0 °F)
- 5.5 bar @ 24 °C (80 psi @ 75 °F)
- 3 bar @ 120 °C (45 psi @ 248 °F)

See Temperature and Pressure graphs for more information

Shipping Weight 0.115 kg 0.25 lb

Standards and Approvals

- CE
- RoHS compliant
- Manufactured under ISO 9001 for Quality and ISO 14001 for Environmental Management

Ordering Information

Sensor Part Number		
3-2507.100	Mini-flow low flow sensor with free-running rotor	
↓	Insert Option	
	-2V	With 2 mm insert; for 0.15 to 0.740 gpm (400 to 2800 mL/m)
	-3V	With 3 mm insert, for 0.185 to 1.123 gpm (700 to 4200 mL/m)
	-4V	With 4 mm insert, for 0.343 to 1.585 gpm (1300 to 6000 mL/m)
	-6V	With 6 mm inlet, no insert, for 0.845 to 3.170 gpm (3200 to 12000 mL/m)
↓		
3-2507.100	-2V Example Part Number	

Mfr. Part No.	Code
3-2507.100-2V	198 801 732
3-2507.100-3V	198 801 733

Mfr. Part No.	Code
3-2507.100-4V	198 801 734
3-2507.100-6V	198 801 736

Accessories and Replacement Parts

Mfr. Part No.	Code	Description
3-2507.080-2	198 801 550	Rotor, 2507
3-2507.080-3	198 801 547	Quad ring, 2507
3-2507.080-5	198 801 508	DIN connector, 2507
3-2507.081-2	198 801 502	2 mm insert
3-2507.081-3	198 801 503	3 mm insert
3-2507.081-4	198 801 558	4 mm insert
5523-0222	159 000 392	Cable (per foot), 2 cond. w/shield, 22 AWG