

Signet 2536 Rotor-X Paddlewheel Flow Sensors

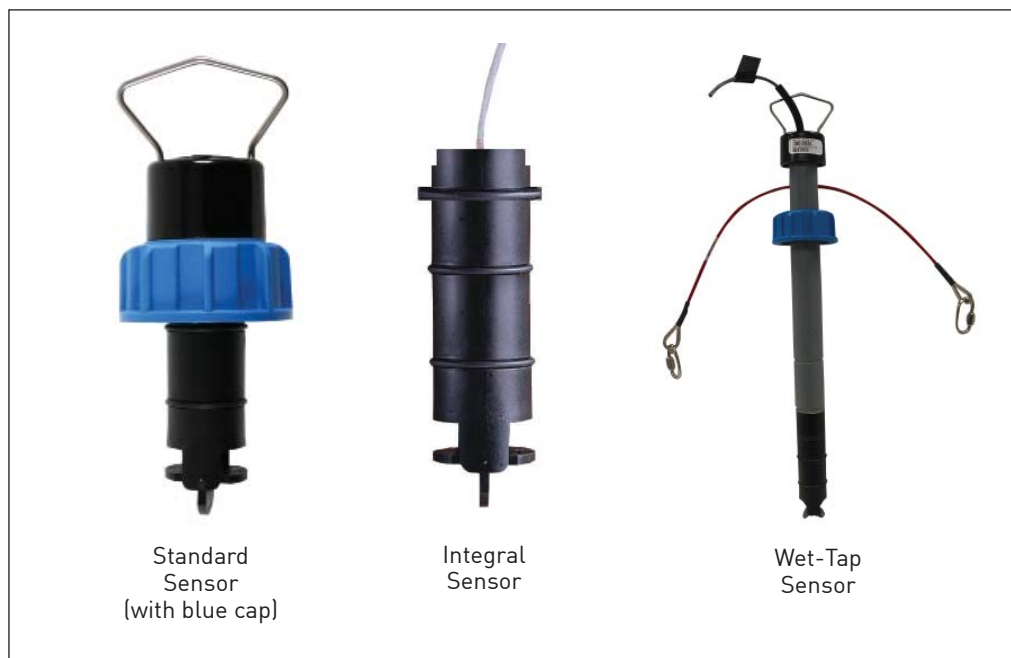

Standard Sensor
(with blue cap)

Integral Sensor

Wet-Tap Sensor

Features

- Operating range 0.1 to 6 m/s (0.3 to 20 ft/s)
- Wide turndown ratio of 66:1
- Open-collector output
- Simple, economical design
- Highly repeatable output
- Installs into pipe sizes DN15 to DN900 (½ to 36 in.)
- High resolution and noise immunity
- Test certificate included for -X0, -X1
- Chemically resistant materials

Description

Simple to install with time-honored reliable performance, Signet 2536 Rotor-X Paddlewheel Flow Sensors are highly repeatable, rugged sensors that offer exceptional value with little or no maintenance. The Model 2536 has a process-ready open collector signal with a wide dynamic flow range of 0.1 to 6 m/s (0.3 to 20 ft/s). The sensor measures liquid flow rates in full pipes and can be used in low pressure systems.









The Signet 2536 sensors are offered in a variety of materials for a wide

range of pipe sizes and insertion configurations. The many material choices including PP and PVDF make this model highly versatile and chemically compatible to many liquid process solutions. Sensors can be installed in DN15 to DN900 (½ to 36 in.) pipes using Signet's comprehensive line of custom fittings. These custom fittings, which include tees, saddles, and weldolets, seat the sensor to the proper insertion depth into the process flow. The sensors are also offered in configurations for wet-tap installation requirements.

Applications

- Pure Water Production
- Filtration Systems
- Chemical Production
- Liquid Delivery Systems
- Pump Protection
- Scrubbers/Gas stacks
- Gravity Feed Lines
- Not suitable for gases

System Overview (For overview of Wet-Tap System, see 3519 product page)

<p>Panel Mount Signet Flow Instrument (sold separately) 5075 8550 5500 8900 5600</p> 	<p>Pipe, Tank, Wall Mount Signet Flow Instrument (sold separately) 8550</p>  <p>Signet Universal Adapter Kit (3-8050) (sold separately)</p> 	<p>Integral Mount Signet Flow Instrument (sold separately) 8550</p>  <p>Signet Integral Adapter Kit (3-8051) (sold separately)</p> 
<p>Signet Model 2536 Standard or Wet-Tap Flow Sensor (not shown)</p> 	<p>Signet Model 2536 Standard or Wet-Tap Flow Sensor (not shown)</p> 	<p>Signet Model 2536 Integral Flow Sensor</p> 
<p>Signet Fittings* (sold separately)</p> 		



*See Fittings section for more information.

Dimensions

2536 Standard Mount Sensor

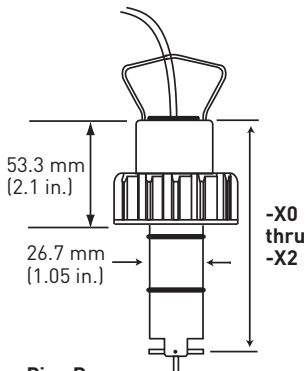

Pipe Range

½ to 4 in.	-X0 = 104 mm (4.1 in.)
5 to 8 in.	-X1 = 137 mm (5.4 in.)
10 in. and up	-X2 = 213 mm (8.4 in.)

2536 Integral Mount Sensor shown with Transmitter (sold separately)

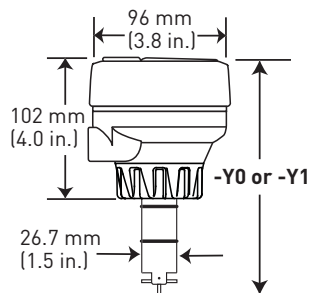

Pipe Range

½ to 4 in.	-Y0 = 152 mm (6.0 in.)
5 to 8 in.	-Y1 = 185 mm (7.3 in.)

2536 Wet-Tap Mount Sensor with 3519 Wet-Tap Valve

See 3519 product page for more information.

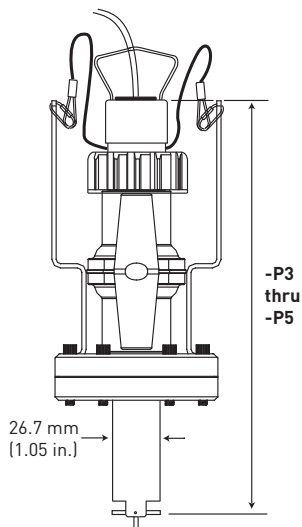

Pipe Range

½ to 4 in.	-P3 = 297mm (11.7 in.)
5 to 8 in.	-P4 = 333mm (13.1 in.)
10 in. and up	-P5 = 409mm (16.1 in.)

Specifications

General

Operating Range: 0.1 to 6 m/s (0.3 to 20 ft/s)
 Pipe Size Range: DN15 to DN900 (½ to 36 in.)
 Linearity: ±1% of max. range @ 25 °C (77 °F)
 Repeatability: ±0.5% of max. range @ 25 °C (77 °F)
 Min. Reynolds Number Required: 4500

Wetted Materials

Sensor Body: Glass-filled PP (black) or PVDF (natural)
 O-rings: FPM (std) optional EPR (EPDM) or FFPM
 Rotor Pin: Titanium, Hastelloy-C or PVDF; optional Ceramic, Tantalum or Stainless Steel
 Rotor: Black PVDF or Natural PVDF; optional Tefzel®, with or w/o Fluoroloy G® sleeve for rotor pin

Electrical

Frequency: 49 Hz per m/s nominal (15 Hz per ft/s nominal)
 Supply Voltage: 5 to 24 VDC ±10%, regulated
 Supply Current: <1.5 mA @ 3.3 to 6 VDC <20 mA @ 6 to 24 VDC

Output Type: Open collector, sinking 10 mA max.

Cable Type: 2-conductor twisted pair with shield 22 AWG

Cable Length: 7.6 m (25 ft) can be extended up to 305 m (1,000 ft) maximum

Max. Temperature/Pressure Rating

Standard and Integral Sensor

- PP: 12.5 bar @ 20 °C, 1.7 bar @ 85 °C (180 psi @ 68 °F, 25 psi @ 185°F)
- PVDF: 14 bar @ 20 °C, 1.7 bar @ 85 °C (200 psi @ 68 °F, 25 psi @ 185 °F)

Operating Temperature:

- PP: -18 °C to 85 °C (0 °F to 185 °F)
- PVDF: -18 °C to 85 °C (0 °F to 185 °F)

Wet-Tap Sensor

PP: 7 bar @ 20 °C, 1.4 bar @ 66 °C (100 psi @ 68 °F, 20 psi @ 150 °F)
 Operating Temperature: -18 °C to 66 °C (0 °F to 150 °F)
 Max. Wet-Tap Sensor Removal Rating: 1.7 bar @ 22 °C (25 psi @ 72 °F)

See Temperature and Pressure graphs for more information.

Shipping Weight

3-2536-X0	0.454 kg	1.00 lb
3-2536-X1	0.476 kg	1.04 lb
3-2536-X2	0.680 kg	1.50 lb
3-2536-X3	0.794 kg	1.75 lb
3-2536-X4	0.850 kg	1.87 lb
3-2536-X5	1 kg	2.20 lb
3-8512-X0	0.35 kg	0.77 lb
3-8512-X1	0.37 kg	0.81 lb

Standards and Approvals

- CE
- RoHS compliant
- Manufactured under ISO 9001 for Quality and ISO 14001 for Environmental Management

Application Tips

- Use the Conduit Adapter Kit to protect the cable-to-sensor connection when used in outdoor environments. See Accessories section for more information.
- Use a sleeved rotor in abrasive liquids to reduce wear.
- Sensor plug is used to plug installation fitting after extraction of sensor from pipe.
- For liquids containing ferrous particles, use Signet Magmeters.
- For systems with components of more than one material, the maximum temperature/pressure specification must always be referenced to the component with the lowest rating.

Please refer to Wiring, Installation, Accessories and Fittings sections for more information.

Ordering Information

Model 2536 Standard Mount Paddlewheel

When choosing this style of sensor, the instrument can be mounted nearby on a pipe or wall or in a remote location up to 305 m/1000 ft (standard cable length is 7.6 m/25 ft) by connecting the sensor through a standard 3-8050-1 universal junction box. Use Signet fittings for proper seating of the sensor into the process flow.

Sensor Part Number	
3-2536	Flow Sensor for use with remote mount instrument
↓	Body/Rotor/Pin material - Choose One*
	P Polypropylene/Black PVDF/Titanium
	T Natural PVDF/Natural PVDF/Natural PVDF**
	V Natural PVDF/Natural PVDF/Hastelloy-C**
↓	Pipe size - Choose One
	0 0.5 to 4 in.
	1 5 to 8 in.
	2 10 to 36 in.
3-2536	- P 0 Example Part Number

**PVDF available 1/2 in. to 4 in. only

Mfr. Part No.*	Code
3-2536-P0	198 840 143
3-2536-P1	198 840 144
3-2536-P2	198 840 145

Mfr. Part No.*	Code
3-2536-T0	198 840 149
3-2536-V0	198 840 146
3-2536-V1	198 840 147

Model 2536 Integral Mount Paddlewheel

When choosing this style of sensor, the instrument is mounted directly onto the sensor for a local display. See Guidelines below for instructions.

Sensor Part Number	
3-8512	Flow Sensor for integral mounting on the 8150 or 8550 instrument using the 3-8051 adapter (instrument and adapter sold separately)
↓	Body/Rotor/Pin material-Choose one*
	P Polypropylene/Black PVDF/Titanium
	T Natural PVDF/Natural PVDF/Natural PVDF**
	V Natural PVDF/Natural PVDF/Hastelloy-C**
↓	Pipe size - Choose one
	0 1/2 to 4 in.
	1 5 to 8 in. (PP only)
3-8512	- V 0 Example Part Number

**PVDF available 1/2 in. to 4 in. only

Mfr. Part No.*	Code
3-8512-P0	198 864 513
3-8512-P1	198 864 514

Mfr. Part No.*	Code
3-8512-T0	198 864 518
3-8512-V0	198 864 516

Guidelines: Combining a 2536 integral mount flow sensor with an integrally mounted instrument

Option 1

Once an integral mount sensor is chosen, it can be mounted directly to a field mount transmitter by following these guidelines:

- Order the integral adapter kit 3-8051 (sold separately) to connect the sensor to an instrument.
- Order a field mount transmitter (sold separately). The following part numbers are compatible: 3-8550-1, 3-8550-2, 3-8550-3, 3-8150-1.

- Assembling the sensor with the integral adapter and instrument is quick and simple.

Option 2

These parts can also be ordered as an assembled part. See page 74 "Integral Mount" for more information.

Model 2536 Standard Paddlewheel Flow Sensor

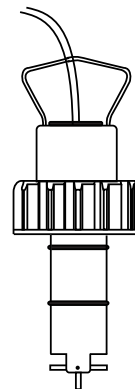

*Model 2536 Ordering Notes

- Most common part number combinations shown. For all other combinations contact factory.
- Other rotor and pin materials are available for purchase from the factory and can be easily replaced in the field. See Accessories section.

Model 2536 Integral Mount Paddlewheel Flow Sensor



Ordering Information (continued)

Model 2536 Wet-Tap sensor

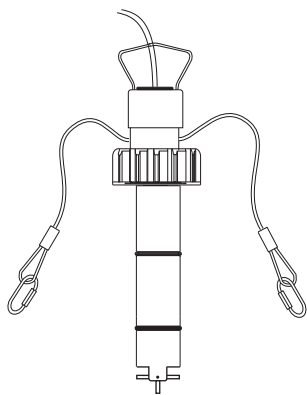

*Model 2536 Ordering Notes

- Other rotor and pin materials are available for purchase from the factory and can be easily replaced in the field. See Accessories section.

Model 2536 Wet-Tap Mount Paddlewheel Flow Sensor

When choosing this style of sensor, the instrument can be mounted nearby on a pipe or wall or in a remote location up to 1000 ft (305 m) by connecting the sensor through a standard 3-8050-1 universal junction box. Standard cable length is 7.6 m (25 ft). This style of sensor uses the 3519 Wet-Tap valve only (see individual product page for more information).

Sensor Part Number - Choose One	
3-2536	Flow Sensor for wet-tap mounting with the 3519 Wet-Tap Valve (sold separately)
↓	Body/Rotor/Pin Material*
	P Polypropylene/Black PVDF/Titanium
	Pipe Size - Choose One
	3 ½ to 4 in.
	4 5 to 8 in.
	5 10 to 36 in.
	↓
3-2536	- P 3 Example Part Number

Mfr. Part No.*	Code
3-2536-P3	159 000 758
3-2536-P4	159 000 759
3-2536-P5	159 000 760

Guideline: Combining a 2536 Wet-Tap Sensor with a 3519 Wet-Tap Valve

- Once a sensor is chosen, it can be mounted in a 3519 Wet-Tap Valve (sold separately)
- Assembling a sensor with a 3519 Wet-Tap valve is quick and simple. These parts can also be ordered as complete assemblies. See 3519 product page.

Accessories and Replacement Parts

Rotor

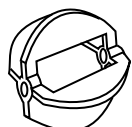

Rotor Pin



Sleeved Rotor
(pin not included)

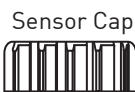
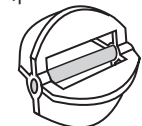

Sensor Cap

Sensor Plug

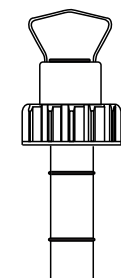

Conduit Adapter Kit

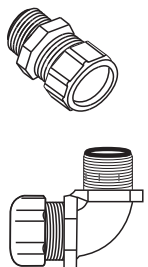

Mfr. Part No.	Code	Description
Rotors		
3-2536.320-1	198 820 052	Rotor, PVDF Black
3-2536.320-2	159 000 272	Rotor, PVDF Natural
3-2536.320-3	159 000 273	Rotor, Tefzel®
3-2536.321	198 820 054	Rotor and pin (matched set), PVDF Natural
3-2536.322-1	198 820 056	Sleeved rotor, PVDF Black
3-2536.322-2	198 820 057	Sleeved rotor, PVDF Natural
3-2536.322-3	198 820 058	Sleeved rotor, Tefzel®
Rotor Pins		
M1546-1	198 801 182	Pin, Titanium
M1546-2	198 801 183	Pin, Hastelloy-C
M1546-3	198 820 014	Pin, Tantalum
M1546-4	198 820 015	Pin, Stainless Steel
P51545	198 820 016	Pin, Ceramic
O-Rings		
1220-0021	198 801 186	O-ring, FPM (2 required per sensor)
1224-0021	198 820 006	O-ring, EPR (EPDM) (2 required per sensor)
1228-0021	198 820 007	O-ring, FPM (2 required per sensor)
Miscellaneous		
P31536	198 840 201	Sensor plug, Polypropylene
P31542-3	159 000 464	Sensor cap, Blue
P31934	159 000 466	Conduit cap
P51589	159 000 476	Conduit adapter kit
5523-0222	159 000 392	Cable (per foot), 2 cond. w/shield, 22 AWG
3-8050	159 000 184	Universal mount kit
3-8050.390-1	159 001 702	Retaining nut replacement kit, Valox K4530
3-8050.391	159 001 703	Retaining nut replacement kit, Stainless Steel
3-8051	159 000 187	Transmitter integral adapter (for use with 8510 and 8512)
3-8050-1	159 000 753	Universal junction box