

# Signet 8250-2 Level Transmitter



3-8250.090-2

Rev. F 3/06

English



## CAUTION!

- Remove power to unit before wiring input and output connections.
- Follow instructions carefully to avoid personal injury.

## Contents

- |                           |                      |
|---------------------------|----------------------|
| 1. Description            | 7. Editing procedure |
| 2. Specifications         | 8. Calibrate menu    |
| 3. Panel installation     | 9. Options menu      |
| 4. Electrical Connections | 10. Troubleshooting  |
| 5. System configuration   |                      |
| 6. View menu              |                      |

## 1. Description

- ProcessPro transmitters are available in two styles: panel mount and field mount. The panel mount is supplied with the necessary hardware to install the transmitter. This manual includes complete panel mounting instructions.
- Field mounting requires one of two separate mounting kits. The 3-8052 integral kit joins sensor and instrument together into a single package. The 3-8050 Universal kit enables the transmitter to be installed virtually anywhere.
- Detailed instructions for integral mounting or other field installation options are included with the 3-8052 Integral kit or the 3-8050 Universal kit.

## 2. Specifications

### Dimensions

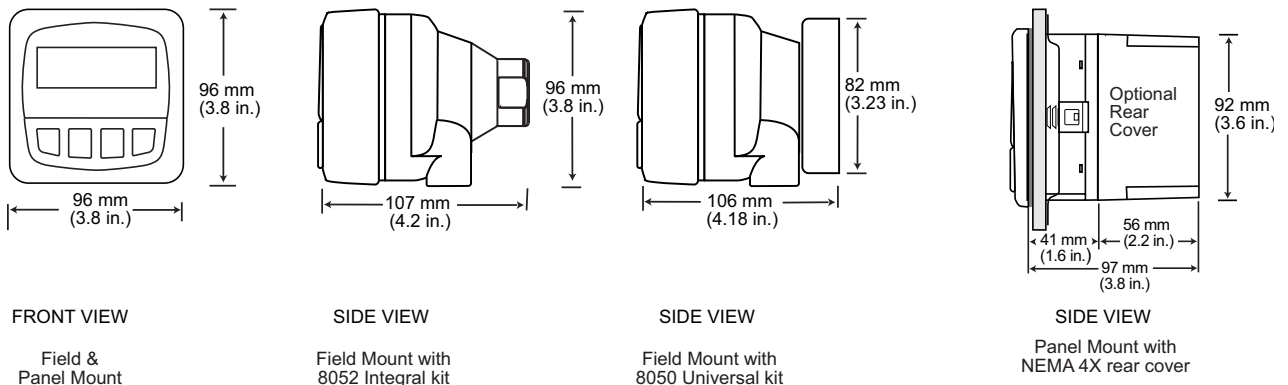

### General

Compatible Sensors: Signet 2450 Pressure sensor  
 Enclosure: NEMA 4X/IP65 front  
 Materials:  
 • Case: PBT  
 • Panel case gasket: Neoprene  
 • Window: Polyurethane-coated polycarbonate  
 • Keypad: Silicone rubber  
 Weight: Approx. 325 g (12 oz.)

### Display:

- Alphanumeric 2 x 16 LCD
- Sealed 4-button keypad
- Display update rate: 1 second
- Contrast: User selected, 5 levels

### Environmental

- Operating temperature: -10 to 70°C (14 to 158°F)
- Storage temperature: -15 to 80°C (5 to 176°F)
- Relative humidity: 0 to 95%, non-condensing
- Maximum altitude: 2000 m (6562 ft)

### Electrical

Power supply: 12-24 VDC ±10% regulated, 250 mA max current  
 Sensor power: 5 VDC ±1% @ 25°C, regulated  
 2-wire system: 1.5 mA maximum current  
 4-wire system: 20 mA maximum current

### Current output:

- 4 to 20 mA, isolated, fully adjustable and reversible
- Max loop impedance: 50 Ω max. @ 12 V, 325 Ω max. @ 18 V, 600 Ω max. @ 24 V
- Update rate: 300 ms
- Output accuracy: ±0.03 mA

### Relay outputs:

- \* 2 sets mechanical SPDT contacts standard with all units.
- Software supports 2 additional relays via optional external relay module
- Maximum voltage rating: 5 A @ 30 VDC, or 5 A @ 250 VAC, resistive load
- Programmable for High or Low setpoint or for Window range, with adjustable hysteresis
- May be disabled if not used
- Time delay: programmable from 0 to 6400 s

### Standards and Approvals:

- CE, UL listed
- Immunity: EN50082-2
- Emissions: EN55011
- Safety: EN61010
- Manufactured under ISO 9001 and ISO 14001

### 3. Panel Installation

1. The panel mount transmitter is designed for installation using a 1/4 DIN Punch. For manual panel cutout, an adhesive template is provided as an installation guide. The cutout must be 92 mm x 92 mm. Recommended clearance on all sides between instruments is 25 mm/1 in.
2. Slide the instrument into the cutout from the front of the panel.
3. Slide the mounting bracket over back of instrument until quick-clips snap into latches on side of instrument.
4. To remove, secure instrument temporarily with tape from front or grip from rear of instrument. **DO NOT RELEASE.** Press quick-clips outward and remove.

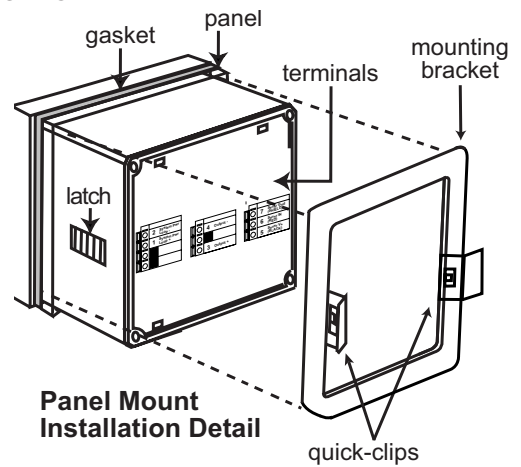

### 4. Electrical Connections

#### Wiring Procedure

1. Remove 0.5 - 0.625 in. (13-16 mm) of insulation from wire end.
2. Press the orange terminal lever downward with a small screwdriver to open terminal jaws.
3. Insert wire into terminal until it bottoms out.
4. Release orange terminal lever to secure wire in place. Gently pull on each wire to ensure a good connection.

#### Wiring Removal Procedure

1. Press the orange terminal lever downward with a small screwdriver to open terminal jaws.
2. When fully open, remove wire from terminal.

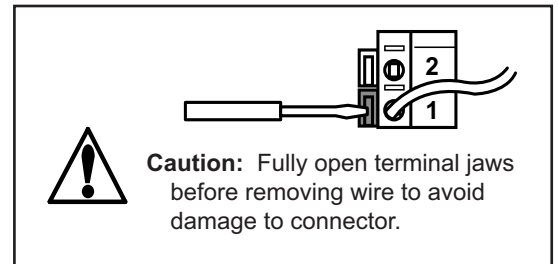

**Terminals 3 and 4: Loop Power**  
 12-24 VDC ±10% system power and current loop output.  
 Max. loop impedance:  
 50Ω max. @ 12 V  
 325Ω max. @ 18 V  
 600Ω max. @ 24 V

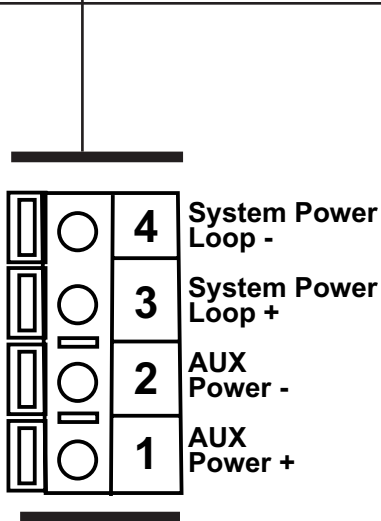

**Terminals 1 and 2: AUXILIARY power**  
 Required for all systems that include relay operation.

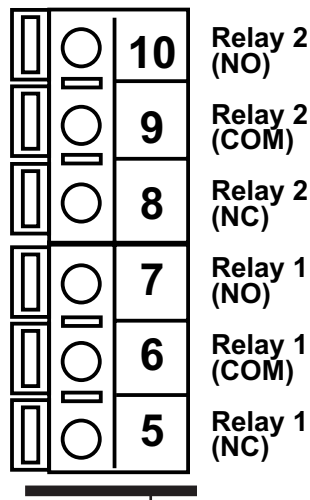

**Terminals 5-10: Relay Outputs**  
 2 sets mechanical SPDT contacts programmable as:

- High or Low setpoint with adjustable hysteresis
- "Window" limits with adjustable hysteresis
- Time delay up to 6400 seconds.
- May be disabled (Off) if not used.
- Auxiliary power (terminals 1-2) **MUST** be connected for relay operation

**Terminals 11-13: Digital (S<sup>3</sup>L) input/output**  
 The 2450 sensor and External Relay Module connect here.

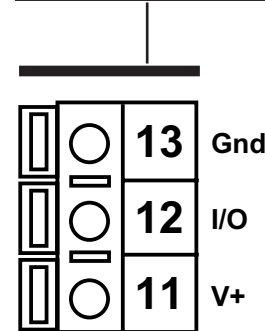

4.1 System Power/Loop Connections

Stand-alone application, no current loop used

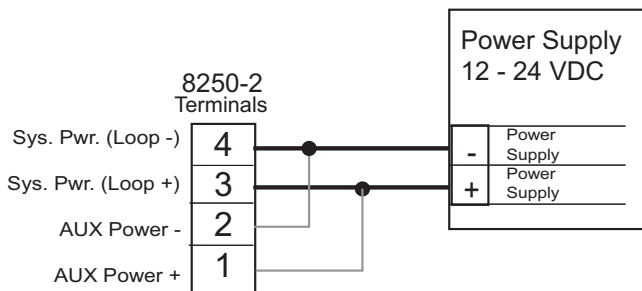

Connection to a PLC with built-in power supply

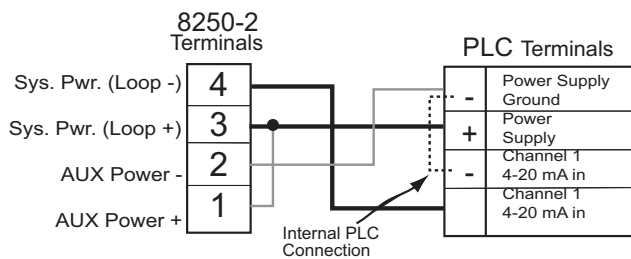

Connection to a PLC/Recorder, separate supply

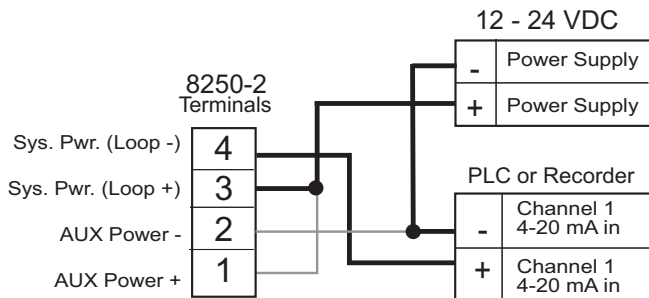

Two transmitters connected to PLC/Recorder with separate power supply

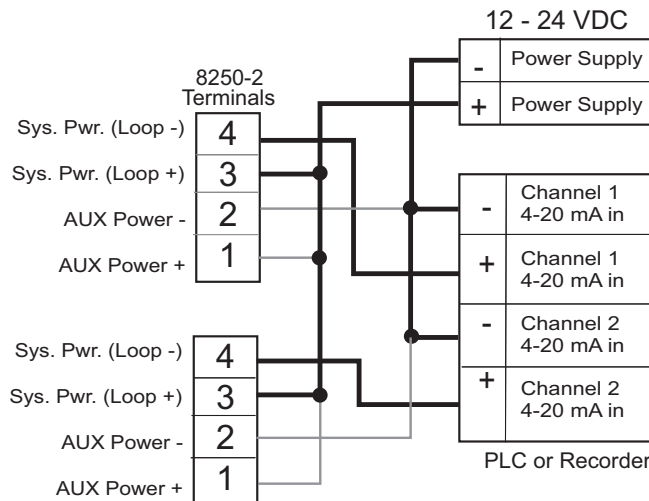

Note:  
**AUXILIARY** power is required to operate the relays.

4.2 Serial Data Connections

- The Input/Output terminals on the 8250 carry S<sup>3</sup>L™ serial data from the 2450 Pressure sensor and from the External Relay Module.
- You MUST reset sensor configuration (see Calibrate menu) for all new systems and after connecting a new sensor or relay module to the I/O terminals.
- Do not route sensor or output cables in conduit containing AC power wiring. Electrical noise may interfere with sensor signal.
- Routing cable in grounded metal conduit will help prevent electrical noise and mechanical damage.
- Seal cable entry points to prevent moisture damage.
- Only one wire should be inserted into a terminal. Splice double wires outside the terminal.
- The **TOTAL** cable length from I/O devices to the transmitter must not exceed 122 m (400 ft.).
- For best performance, ground the sensor SHIELD wire to a local earth ground at a point near the sensor.
- Consult the sensor manual for additional wiring information.

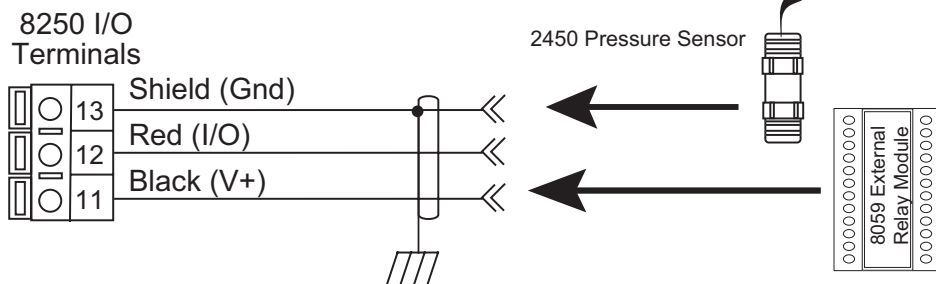

The TOTAL cable length connected to the 8250 input/output terminals must not exceed 122 m (400 ft.)

The External Relay Module provides terminals to connect the sensor in series.

## 5. System Configuration

The 8250 Level Transmitter must be programmed using the following system configuration procedure.

1. Determine where you want the level measurement to start. This is the Zero reference point (Z).  
Review the diagram to help select the best option.
2. Determine where you will mount the sensor. This is  $S_{Loc}$ .  
Consult the Sensor manual for information regarding the best location for the sensor.
3. Measure the distance between Z and  $S_{Loc}$ . This is **O(ffset)**.
4. Enter the Offset into the Calibrate menu.

### Zero reference point (Z):

Definition:

The point in the vessel where you want the 8250 to display zero (0 ft., 0 gal. etc).

- If Z is located below the fluid surface, the 8250 will display a positive level measurement.
- If Z is located above the fluid surface, the 8250 will display a negative level measurement.

### Sensor Location point ( $S_{Loc}$ ):

Definition:

The point on the level sensor where the measurement is taken.

- The 2450 Pressure sensor measures from the centerline of the diaphragm.

### Offset (O):

Definition:

The distance from the zero reference point (Z) to the sensor location point ( $S_{Loc}$ ).

- Enter a positive value in the Calibrate menu if the sensor is located above Z (zero reference point).
- Enter a negative value in the Calibrate menu if the sensor is located below Z (zero reference point).
- Enter 0 in the Calibrate menu if the sensor is located at Z (zero reference point).

### Level (L):

Definition:

- The distance from Z (zero reference point) to surface of fluid (displayed as "Level" by transmitter).

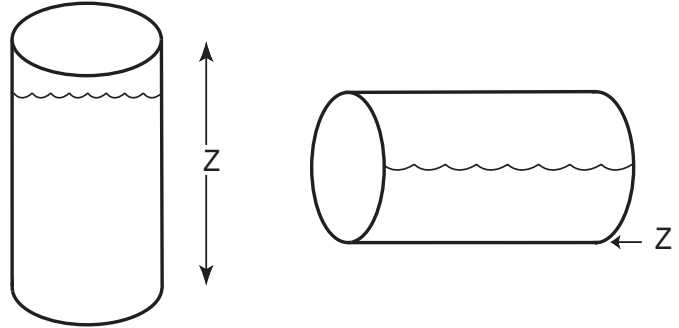

For most vessels, the zero reference point may be designated as any height in the vessel.

For horizontal cylinders only, the zero reference point **MUST** be the lowest point in the vessel.

### 2450 Pressure Sensor Location and Offset

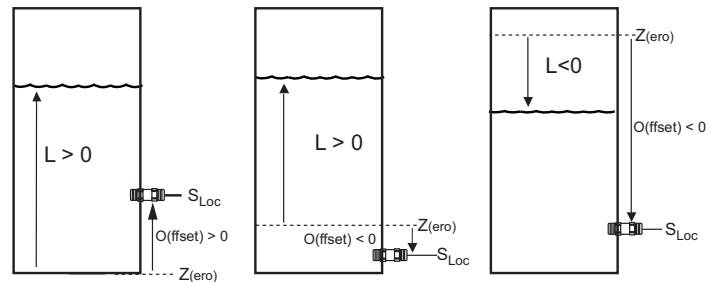

**5.1 Level and Volume conversion in custom shaped vessels**

If you select Custom Shape in the Options menu, you can define from 2 to 10 Custom Points to establish the relationship of level to volume in the vessel.

- Select Manual level Measurement mode to edit both level and volume data (dry configuration).
- Select Automatic level Measurement mode to accept the sensor measurement of the Level, while you assign a volumetric value to each custom point (wet configuration).
- Enter from 3 to 10 custom points to link level and volume values.
- The first custom point must be the lowest fluid level in the vessel.
- Each successive point must be greater than the preceding point.
- The last point must be equal to or greater than the highest fluid level in the vessel.
- A custom point should be located at all transition points in the vessel shape (for example, at custom point #9, where the shape changes from a cylinder to a cone).
- The more complex sections should be defined with more points. Notice that the conical section of the illustration has been defined by custom points 1 through 9.
- Simpler sections require fewer defining points. Note that the cylinder requires only custom points 9 and 10.

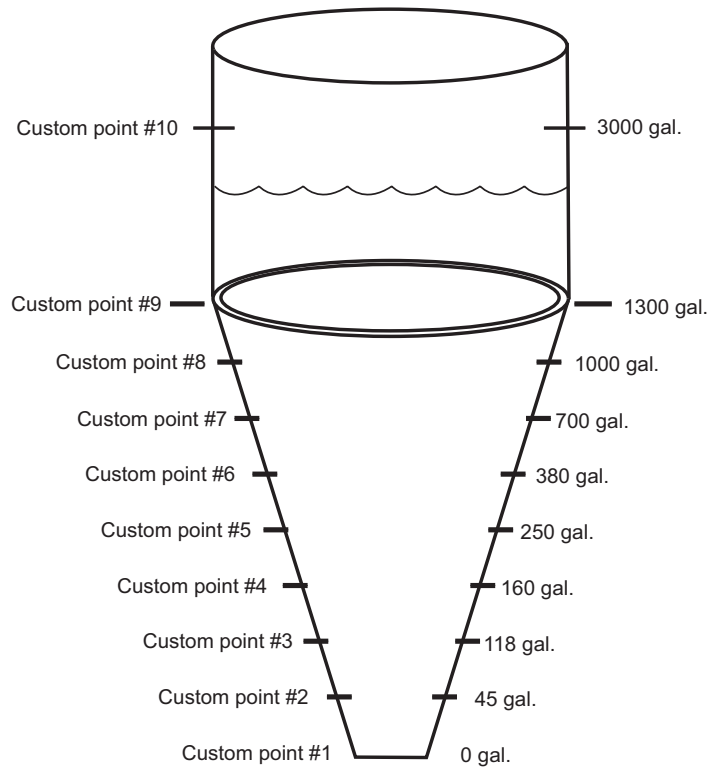

**5.2 Reference**

Level, volume and mass calculations performed by the 8250 include:

**Pressure to level conversion:**  
 $Level = P \div (SG \cdot D_{(water)})$   
 where P = Pressure  
 SG = Specific Gravity of fluid  
 $D_{(water)}$  = Density of water

With pressure in psi: Level (meters) =  $(0.703069 \cdot P / SG)$   
 with pressure in bar: Level (meters) =  $1.019715 \cdot P / SG$

**Mass conversion**

$m = D_{(water)} \cdot SG \cdot V$

where m = mass of fluid  
 $D_{(water)}$  = Density of water = 1000 kg/m<sup>3</sup>  
 SG = Specific Gravity of fluid  
 V = Volume of fluid (m<sup>3</sup>)

$m (kg) = 1000 \cdot SG \cdot V$

**Volume calculations**

Vertical cylinder:  $V = \pi \cdot d^2 \cdot h / 4$   
 where d = diameter of cylinder  
 h = height of fluid

Rectangular vessel:  $V = w \cdot l \cdot h$   
 where w = width  
 l = length

Horizontal cylinder:  $V = A \cdot L$

where A = area of segment  
 L = Length of vessel

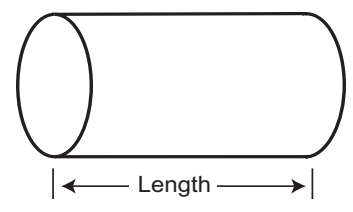
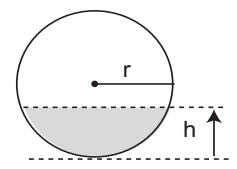

Custom vessel:  
 The 8250 performs linear interpolation between adjacent points.

### 5.3 Relay Operation

Relay outputs can be used as switches that respond when the process variables move above or below setpoints, or when the process variables move outside of a window.

- The relays may be turned Off if not in use.
- Response can be delayed up to 6400 s ( see Calibrate menu).

#### Low:

Relay is energized when process variable is less than the setpoint. The relay relaxes when the process variable moves above the setpoint plus the hysteresis value.

#### High:



Relay is energized when process variable is greater than the setpoint. The relay relaxes when the process variable moves below the setpoint plus the hysteresis value.

#### Window

Relay is energized when the process variable moves above or below a fixed window of values. The relay relaxes when the process variable moves inside the window by more than the hysteresis value.

#### Note:

Relays will operate in reverse if miswired. Observe relay logic appropriate to the application.

Relay energized   
 Relay deenergized 

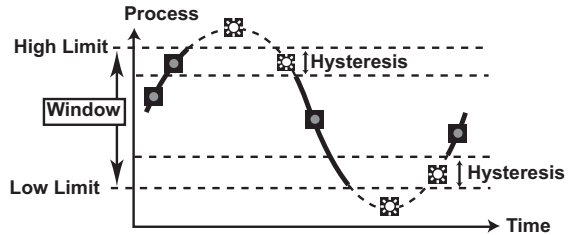
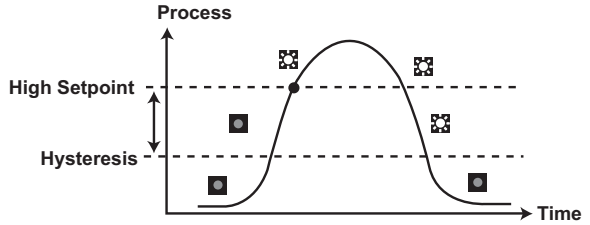
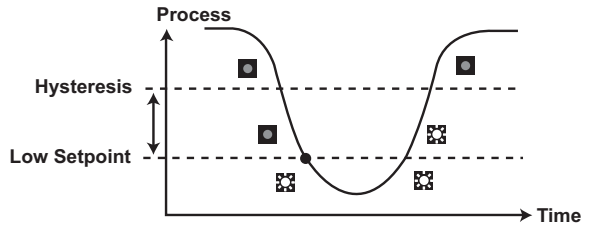

## 6. VIEW menu

- During normal operation, the ProcessPro displays the VIEW menu.
- To select a display, press the UP or DOWN arrow keys. The display selections scroll in a continuous loop.
- Changing the display selection does not interrupt system operations.
- No keycode is necessary to change display selection.
- Output settings cannot be edited from the VIEW menu.
- When using the CALIBRATE or OPTIONS menus, the ProcessPro will return to the VIEW menu if no key is pressed for 10 minutes.

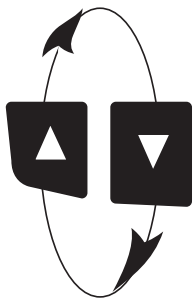

### View Menu

Display	Description
---------	-------------

The following displays are permanent. They will remain as selected until you change them.

Level + 10.00 ft	Displays the Level value. Permanent display when "Level" is the display selection in OPTIONS menu.
Volume +30.00 gal	Displays the Volume value. Permanent display when "Volume" is the display selection in OPTIONS menu.
LVL +10.00 ft VOL +300.00 gal	Displays the Level and Volume simultaneously. Permanent display when "Both" is the display selection in OPTIONS menu.

The following displays are temporary. The permanent display will return after ten minutes.

Loop Output: 19.00 mA	Displays the Loop (4-20 mA) output.
Relay A: On Relay B: Off	Displays the status of Relays A and B. Appears only when external relay module is detected.
No Relay Module Detected	Displayed if the relay module is not detected at Sensor Configuration (see calibrate menu).
Last Cal: 09-03-04	Displays the date for scheduled maintenance or date of last calibration.



## 8. Calibrate Menu

Display (Factory settings shown)	Description
<b>LVL Units:</b> ft >	Select the units of measure: ft, in, m,cm.
<b>Show LVL in %:</b> No >	Yes: Level will be displayed as a percentage of the full scale. No: Level will be displayed as engineering units.
<b>LVL 100%:</b> +0.0000 ft >	If "Show LVL in %" is YES, enter the full scale value. The units are the same as LVL Units
<b>Sensor Offset:</b> +0.0000 ft >	Enter the distance from sensor location to the Zero reference point in the vessel. Enter + if the sensor is located above the Zero reference point. Enter - if the sensor is located below the Zero reference point.
<b>VOL Units:</b> gal >	Select the units of measure for Volume: gal, ft <sup>3</sup> , in <sup>3</sup> , m <sup>3</sup> , kg, lb, or lit (liters)
<b>Show VOL in %:</b> No >	Yes: Volume will be displayed as a percentage of the full scale. No: Volume will be displayed as engineering units.
<b>VOL 100%:</b> +0.0000 gal >	If "Show VOL in %" is YES, enter the full scale value. The units are the same as VOL Units
<b>Spec Gravity:</b> 1.0000 >	Enter the specific gravity of the fluid. Factory setting is 1 (water) This setting is required only if the level measurement is made by a pressure sensor (Signet 2450), or if volume units are selected ( kg or lb ) .
<b>Set LVL:</b> >	Single-point calibration for Level.
<b>Reset LVL to Factory Cal:</b> >	Yes: Reset Level to original factory calibration. ("Set LVL" entry is erased.) No: Return to menu, do not reset Level.

## 8. Calibrate Menu (continued)

Display (Factory settings shown)	Description
<b>Loop Source:</b> LVL >	Select the source for the 4-20 mA Loop: LVL or VOL.
<b>Loop Rng: ft</b> +0.0000 → +10.000 >	Select the minimum and maximum values for the 4-20 mA Current loop output.
<b>Relay 1 Mode:</b> Off >	Select the mode of operation for Relay Output: Low, High, or Window. The relay may be disabled (Off) if not in use.

The Relay settings below will not appear if the Relay mode is OFF

<b>Relay 1 Source:</b> LVL >	Select the source for Relay: LVL or VOL.
<b>Relay 1 Setpnt:</b> +0.0000 ft >	If Relay is in Low or High mode, the relay will be activated when the level or volume reaches this value.
<b>Relay 1 Rng: ft</b> +0.0000 → +10.000 >	If Relay is in Window mode, the relay will be activated when the level or volume is less than (low limit) or greater than (high limit) the range. You must enter the low limit into the first field, and the high limit into the second field.
<b>Relay 1 Hys:</b> 0.00 ft >	Relay will be deactivated at Setpoint ± Hysteresis. The Hysteresis value is in Level units or % of full scale.
<b>Relay 1 Delay:</b> 0.0 secs >	Set up to 6400 seconds delay time for relay response. Relay will be activated only if the source value exceeds the setpoint for this time period.

- Relay settings will repeat for Relay #2 and for External relays A and B.
- A and B Relays require the optional External Relay Module (model number 3-8059)

<b>Reset Sensor Configuration:</b> >	Use this function during initial startup of a new system, and whenever a new sensor is added to the system. It enables the 8250 to scan the sensor input terminals and determine the type and specific serial numbers of the sensors connected to the sensor input.
<b>Last Cal:</b> 09-03-04 >	Use this "note pad" to record important dates, such as annual recertification or scheduled maintenance.

## 9. Options Menu

Display (Factory settings shown)	Description
<b>Contrast:</b> 3 >	Adjust the LCD contrast for best viewing. A setting of 1 is lower contrast, 5 is higher. In general, select lower contrast if the display is in warmer ambient surroundings.
<b>Display Option:</b> <b>Level</b> >	Select Level, Volume or Both. This setting will determine the permanent display selection.
<b>Average:</b> <b>Off</b> >	<b>Off</b> provides near-instantaneous response to measurement changes. <b>Low</b> (4 s averaging) <b>Medium</b> (8 s averaging) or <b>High</b> (32 s averaging) will stabilize the system if your process experiences frequent fluctuations or surface turbulence.
<b>Decimal:</b> ***.** >	Set the decimal to the best resolution for your application. The display will automatically scale up to this restriction. Select *****, ****.*, ***.** or **.**
<b>Loop Adjust:</b> 4.00 mA >	Adjust the minimum and maximum current output. The display value represents the precise current output. Adjustment limits: <ul style="list-style-type: none"> <li>The 4.00 mA output can be adjusted from 3.80 mA minimum to 5.00 mA maximum</li> <li>The 20.00 mA output can be adjusted from 19.00 mA minimum to 21.00 mA maximum</li> <li>Use these adjustments to match the system output to any external device.</li> </ul>
<b>Loop Adjust:</b> 20.00 mA >	
<b>Test Loop:</b> >	Press UP and DOWN keys to manually order any output current value from 3.6 mA to 21.00 mA to test the output loop.
<b>Test Relay 1</b> >	Press UP and DOWN keys to manually toggle Relay #1 Off and On.
<ul style="list-style-type: none"> <li>Relay settings will repeat for Relay #2 and for external Relays A and B.</li> </ul>	
<ul style="list-style-type: none"> <li>The following entries are used by the 8250 to convert the level into volumetric and mass measurements. The accuracy of the entries entered will determine the accuracy of the volumetric and mass calculation. Refer to section 5 for additional information.</li> </ul>	
<b>VOL Shape:</b> <b>Vert Cylinder</b> >	Select the shape of the vessel where Sensor is located: <b>Vert Cylinder, Horiz Cylinder, Rectangular or Custom</b>
<b>VOL Diameter:</b> 0.0000 ft >	<b>If Vert Cylinder or Horiz Cylinder is selected:</b> Set the diameter of the cylinder The unit of measure is set by "LVL Units" in Calibrate menu.
<b>VOL Length:</b> 0.0000 ft >	<b>If Horizontal Cylinder or Rectangular shape is selected:</b> Set the length of the vessel. The unit of measure is set by "LVL Units" in Calibrate menu.
<b>VOL Width:</b> 0.0000 ft >	<b>If Rectangular shape is selected:</b> Set the width of the vessel. The unit of measure is set by "LVL Units" in Calibrate menu.
<b>Number of Custom Points:</b> 10 >	<b>If Custom shape is selected,</b> enter the number of manual calibration points to be entered. Minimum is 3 points, maximum is 10 points.
<b>LVL Measurement:</b> <b>Manual</b> >	<b>If Custom shape is selected:</b> select Manual or Automatic level measurement. Manual allows you to Edit both the Level measurement and the Volume measurement. Automatic allows you to Edit only the Volume measurement (while displaying Level value)
<b>P01:</b> +0.0000 ft <b>V:</b> +0.0000 gal >	Set the Volume (and Level if manual measurement is selected) at each custom point in your vessel.

## 10. Troubleshooting

Display Condition	Possible Causes	Suggested Solutions
"Value must be 6400 or less"	Time delay cannot be greater than 6400 s.	Set time delay to a 6400 s or less.
"Value must be more than zero"	Specific gravity value set to 0.0000	Set Specific gravity to a value greater than 0.
"Must have more than 1 point" "Must have 10 or less points"	Custom Shape requires from 3 to 10 custom points.	Set number of custom shape points to a value from 3 to 10.
"Must be > than previous point"	A custom point has been entered that is not greater than the previous point. (Custom points must be in ascending order.)	Reset the custom point to a value greater than the preceding point.
"CustomTable Error"	Number of custom points increased without setting new values so all custom points are not sequential.	Review all custom points and reset values so each point is greater than the preceding point.
"CHK SENSOR" appears in VIEW mode	Sensor-related problem during different operational modes: 1. AUXILIARY POWER was not connected when LOOP power started Wiring problem: 2. The sensor is not connected properly 3. The sensor has not been configured ("CHK SENSOR" and "Too Much Error") 4. The sensor is defective	<ol style="list-style-type: none"> <li>1. Start AUX power, then LOOP power</li> <li>2. Check sensor wiring</li> <li>3. "RESET SENSOR CONFIGURATION" in CALIBRATE menu.</li> <li>4. Replace the sensor, then RESET SENSOR CONFIGURATION.</li> </ol>
"Too Much Error Check Sensor" appears during "SET LVL1" in Calibrate menu		
"0 SENR(S) FOUND: SAVE ?" appears during "Reset Sensor Configuration" in Calibrate menu		
"No Relay Module Found"	<ul style="list-style-type: none"> <li>• External Relay Module wiring is loose</li> <li>• Relay module has been disconnected</li> <li>• Relay module has been replaced</li> <li>• Relay module is defective</li> </ul>	<ol style="list-style-type: none"> <li>1. Check wiring</li> <li>2. RESET SENSOR CONFIGURATION</li> <li>3. Replace External Relay Module.</li> </ol>

## Ordering Information

Mfr. Part No.	Code	Description
3-8250-2	159 000 766	Level Transmitter, Field Mount
3-8250-2P	159 000 767	Level Transmitter, Panel Mount
3-8059-2	159 000 770	External Two-Relay Module
3-8059-2AC	159 000 771	External Two-Relay Module w/Power Supply

## Accessories

Mfr. Part No.	Code	Description
3-8050	159 000 184	Universal mounting kit
3-8050.395	159 000 186	NEMA 4X Back Cover
3-8052	159 000 188	3/4" Integral mounting kit
3-8050.396	159 000 617	RC Filter Kit (for relay use), 2 per kit
3-0000.596	159 000 641	Heavy Duty Wall Mount Bracket
3-9000.392	159 000 368	Liquid-tight connector kit, 3 sets, 1/2 in. NPT5
3-9000.392-1	159 000 839	Liquid-tight connector kit, 1 set, 1/2 in. NPT5
3-9000.392-2	159 000 841	Liquid-tight connector kit, 1 set, PG 13.5
7300-7524	159 000 687	7.5W 24V Power Supply
7300-1524	159 000 688	15W 24V Power Supply
7300-3024	159 000 689	30W 24V Power Supply
7300-5024	159 000 690	50W 24V Power Supply
7300-1024	159 000 691	100W 24V Power Supply

---

**+GF+**

George Fischer Signet Inc., 3401 Aerojet Avenue, El Monte, CA 91731-2882 U.S.A. • Tel. (626) 571-2770 • Fax (626) 573-2057  
For Worldwide Sales and Service, visit our website: [www.gfsignet.com](http://www.gfsignet.com) • Or call (in the U.S.): (800) 854-4090

